

CAD FILE :

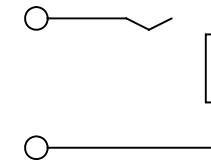

SCHEMATIC

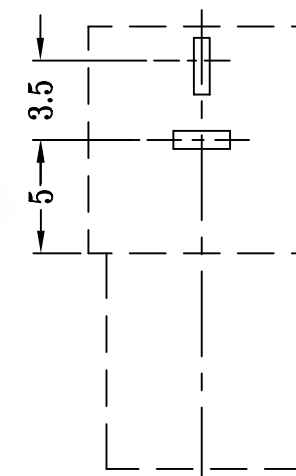
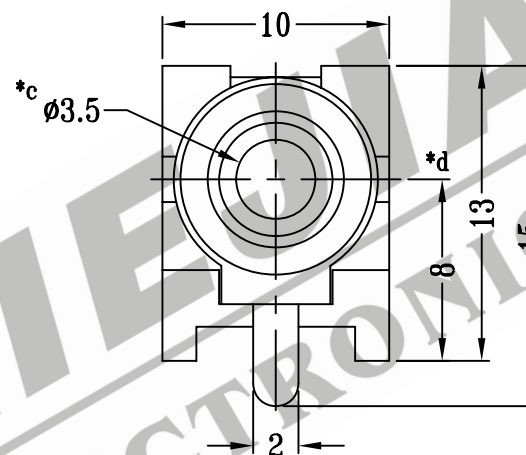
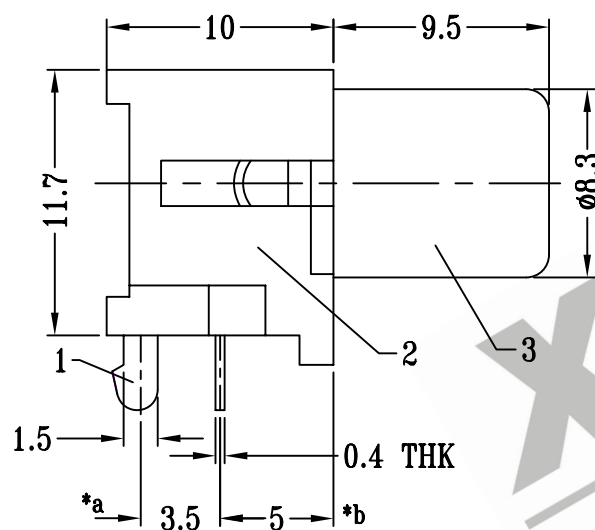

P.C.B LAYOUT

注:带"*"表示关键尺寸(4个)

8					TOLERANCE UNLESS SPECIFIED	SHENZHEN XIEJIA ELECTRONICS CO.,LTD.				
7										
6					WITHIN: 1.5±0.1mm OVER : 1.5±0.2mm	ISSUE	DATE	DESCRIPTIONS		APPD
5										
4					TITLE : RCA JACK		UNIT : M M	DRWG NO : XJ-DR-RC155-00		
3	SLEEVE	BRASS STRIP	1	Cr PLATED	MODEL : RC-155		SCALE : 3:1	DWN.	ZHOUYU	2005-2-1
2	CASE	ABS	1	RED				CHK'D	FANGYING	2005-2-1
1	TERMINAL	BRASS STRIP	1	Ag PLATED OVER Ni PLATED	ALL MATERIALS MUST BE COMPLIANT TO ROHS		APPD.	KANGXINAN	2005-2-1	
NO.	PART NAME	MATERIAL	QTY.	FINISHING						